

**OWNERS AND
OPERATORS MANUAL**

bonefish

B O A T W O R K S

WELCOME

Congratulations on the purchase of a new boat. This manual and its periodic updates posted on the website (“manual”) is intended to help you and all users of the boat understand how it works, how it should be maintained, as well as make your time on the water safe and enjoyable. We manufacture multiple boat models ranging from small unpowered crafts to large multi-engine offshore fishing vessels. Consequently, this manual is necessarily generic in nature, and may not cover specific items that are unique to your model. Likewise, this manual may address items or features that are not included in your boat. In addition, your boat incorporates features and accessories that were not built by us (e.g., stereo equipment, jack plates, shallow water anchors, lighting, steering systems, electronics, fuel tanks and motors) and are therefore not addressed in this manual. The suppliers of these “third party” items provide their own owner’s manuals which are available directly from them (though we have attempted to supply them to you at the time of purchase). You must read the information in this manual and the third-party manuals completely and have a thorough understanding of all component systems and their proper operation before operating your boat. In addition, the “third party” items have their own warranties that is different from what we provide.

All boats are not the same, and operation of a boat on water is nothing like operating a vehicle on a roadway. Roads are relatively smooth and level. Water isn’t. In fact, it’s constantly changing. Tides ebb and flow. Waves increase and decrease size and distance. Obstructions appear out of nowhere. The same body of water has differing conditions all day long and from day to day. As a result, not all boats should be used on all waterways at all times. They have intended uses and associated limitations. For our boats, the maximum limits are as follows:

INSHORE Within 1.5 Miles of Shore. No more than 1.5’ Seas No more than 5kt Winds	NEARSHORE Within 20 Miles of Shore. No more than 3’ Seas No more than 10kt Winds	OFFSHORE Within 60 Miles of Shore No more than 5’ Seas No more than 15kt Winds
Bohemian 17	Ozona 25	Tortuga 30
Diavolo 20	Malvado 26	
Hill Tide 22	Sabalo 23	
Calusa 24	Sabalo 27	
Sabalo 21		

These distances, winds and sea heights are **not** safe or permissible in all circumstances, at all speeds, and under all loads. These are maximum limitations for minimally loaded vessels at safe operating speeds captained by experienced operators. As the boat’s operator, you are responsible for determining what you and the boat are safely capable of in all load, speed, sea and weather conditions. As winds and/or sea conditions deteriorate, your decisions must always be adjusted to maintain safety and control. Regardless, the above chart contains absolute limitations on our boats that should never be exceeded regardless of experience, speed or load.

OPERATOR RESPONSIBILITIES

As the operator of a boat, you are responsible for:

- Reading, understanding and complying with this manual, as well as the express limited warranty applicable to your boat. Warranties are posted on the web site of the brand of boat you purchased.
- Being reasonable. We don’t expect you to be perfect, so please do not expect that from us. Our boats are hand built by multiple people who strive for perfection but don’t always

achieve it. So, if you have an issue, please do not take it personal. We didn't single you out nor are we trying to hurt you in any way. Just let us know and, when applicable, give us a reasonable opportunity to correct it.

- Studying and continuing to refer to this manual and all instructions for your boat and any third party products associated with your boat.
- Being familiar and complying with all local and national regulations applicable to the transportation and operation of the boat.
- Examining your boat and confirming that all systems are working properly at the time of delivery and prior to each use.
- Scheduling regular maintenance for your boat and associated third party products.
- Completing a boater safety course approved by the Florida Fish and Wildlife Commission and currently found at: <http://www.myfwc.com/boating/safety-education/courses/> ("Safety Course").
- Complying with the U.S. Coast Guard's most current Navigation Rules (<https://www.navcen.uscg.gov/pdf/navrules/navrules.pdf>) and Navigation Aids (<http://uscg.mil/d13/docs/usaidstonavigationsystembooklet23dec03.pdf>).

The contents and requirements of the Safety Course and Navigation Aids are a part of this Manual.

Registration and Numbering

US law requires that all undocumented vessels equipped with propulsion machinery be registered in the state of principal use. A certificate of number will be issued upon registering the boat. These numbers must be displayed on your boat. The owner/operator of a boat must carry a valid certificate of number whenever the boat is in use. When moved to a new state of principal use, the certificate is valid for 60 days. In order to be valid, the numbers must be installed to the proper specifications. Check with your dealer or state boating authority for numbering requirements. The Coast Guard issues the certificate of number in Alaska; all others are issued by the state.

Insurance

In most states the boat owner is legally responsible for damages or injuries he or someone else operating the boat causes. Responsible boaters carry adequate liability and property damage insurance for their boat. You should also protect the boat against physical damage and theft. Some states have laws requiring minimum insurance coverage. Contact your dealer or state boating authority for information on the insurance requirements in your boating area.

Reporting Boating Accidents

All boating accidents must be reported by the operator or owner of the boat to the proper marine law enforcement authority for the state in which the accident occurred. Immediate notification is required if a person dies or disappears as a result of a recreational boating accident. If a person dies or there are injuries requiring more than first aid, a formal report must be filed within 48 hours. A formal report must be made within 10 days for accidents involving more than \$500.00 damage or the complete loss of a boat. If you need additional information regarding accident reporting, please call the Boating Safety Hotline, 800-368-5647.

Safety Standards

To meet required standards some of the safety equipment on your boat must be Coast Guard approved. "Coast Guard Approved Equipment" has been determined to be in compliance with USCG specifications and regulations relating to performance, construction or materials. The

equipment requirements vary according to the length, type of boat and the propulsion system. Some of the Coast Guard equipment is described in the Safety Equipment chapter of this manual. For a more detailed description, obtain "Federal Requirements And Safety Tips For Recreational Boats" by contacting the Boating Safety Hotline 800-368-5647. Some state and local agencies impose similar equipment requirements on waters that do not fall under Coast Guard jurisdiction. These agencies may also require additional equipment that is not required by the Coast Guard.

COMMON NAUTICAL TERMS

If you're new to boating, take the time to familiarize yourself with the terminology associated with this activity. It will aid in your understanding of this manual, as well as some of the laws applicable to the operation of your boat. While not exhaustive, this is a list of commonly used terms and their meaning:

Abeam - A line perpendicular to a boat's keel.

Access Plate - A removable, watertight cover that provides quick entry to enclosed areas for maintenance or visual inspection.

Aft - Toward the rear or stern of boat.

Beam - The greatest width of a boat.

Bilge - The lower interior area of the provide access below hull

Bow - The forward/front part of a boat.

Bow Eye - A u-shaped hull fitting used to attach the trailer winch to the boat

Bulkhead - Vertical partition in a vessel fastened inside the hull.

Chine - Meeting juncture of topside and bottom of boat.

Cleat - Deck fitting with arms or horns of a boat on which lines are fastened.

Deck - Upper structure which covers the hull.

Draft - Depth of water required to float a boat.

Fathom - A depth measurement equal to six feet.

Freeboard - Distance between topside and the deck.

Gunwale or Gunnel - Meeting from deck or cockpit junction of hull and deck.

Hatch - An opening in the deck.

Head - A toilet or toilet area in a boat.

Headroom - Vertical distance between the deck and cabin or canopy top.

Hull - The basic part of the boat.

Keel - The major longitudinal member of a hull and the lowest external portion of the hull.

Knot - Unit of speed in nautical miles.

Lee or Leeward - The side that is sheltered from the wind.

List - The tilt or lean to one side.

Port - The left side of the boat when facing the bow.

Scupper - Holes permitting water to drain overboard.

Sheer - Curve or sweep of the deck as viewed from the side.

Starboard - The right side of the boat when facing the bow.

Stern - The rear end of a boat.

Stringer - Longitudinal members that provides structural strength.

Wake - The track or path left in the water by a moving boat through the water.

Windward - Toward the direction from which the wind is blowing against the deck.

MAJOR BOAT OPERATIONS AND SYSTEMS

Now that you have some basic terms under your belt, let's look at some of the basic boat functions you need to understand and have command of to safely operate your boat.

Trim

Most outboard boat models are equipped with power tilt and trim mechanisms. The purpose of power tilt function is to raise the engine for launching, loading or trailering your boat. The power trim function may be used to adjust the boat's planing performance and running attitude. Trim refers both to the weight distribution inside the boat and the angle of thrust of the drive unit. The angle of thrust of the drive unit forces the bow up or down. The proper trim angle will vary depending on the load and weight distribution in your boat. If the drive is trimmed to far in, it will drive the front of the boat down into the water causing a condition known as "bow steer" where the outboard loses its ability to effectively control the direction of the boat. If trimmed to far in in waves, you run the risk of driving the bow beneath the water (also known as "stuffing" a boat). Stuffing a boat can cause harm, damage and could even result in sinking. If the drive is raised too far, you will cause the propeller to "ventilate" or "cavitate", resulting in a sudden increase in engine RPM as well as a loss of speed and control. If this occurs, immediately reduce engine speed and lower the drive until the condition is corrected. In certain circumstances, improper trim and/or weight distribution can cause a boat to rotate or "spin out". Always distribute weight evenly side to side and mostly to the rear of your boat. Never allow persons to sit in any area other than those

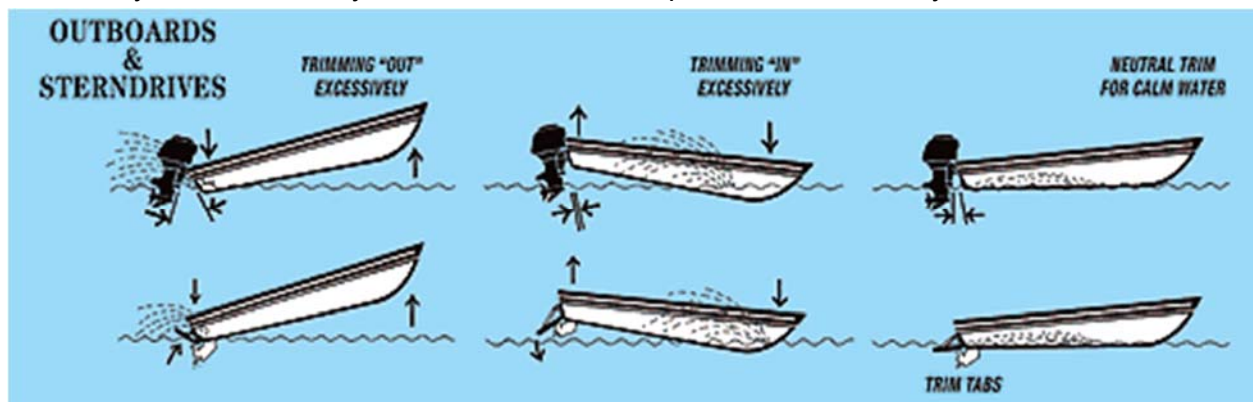
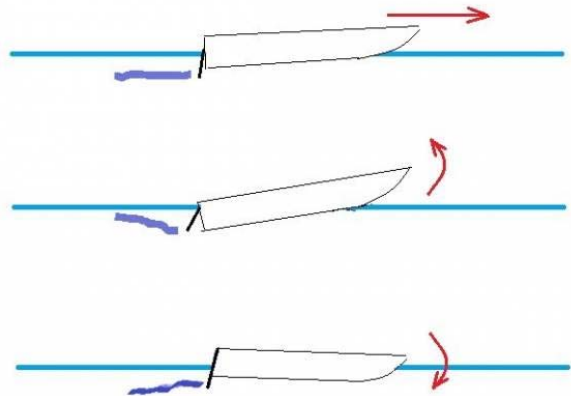

designated specifically for seating. Finally, never exceed the maximum weight printed on the capacity sticker inside your boat.

Propeller

The propeller converts the engine's power into thrust to propel the boat. The right propeller for any boat in a specific application is one that allows the engine to turn up to its full rated RPM, but no more. It is necessary for the engine to turn to full rated rpm in order to develop full rated power. If the boat is used for more than one type of activity, fishing and water skiing for example, the prop can only be optimized for one situation. Since a spare propeller is an excellent safety item, the purchase of a second propeller which is more efficient for another application is not all "added expense". Propellers are identified by two numbers such as 14 x 17,

and a material identification, such as aluminum or stainless steel. The first number is the diameter and the second is the pitch. The diameter is the distance across the circle swept by the extreme tips of the propeller blades. The term pitch comes from the old screw analogy used to approximate propeller action. This analogy says that a propeller screws itself through the water much as a wood screw works itself into soft pine. The pitch is the angle of the blades expressed in the theoretical distance a propeller would travel in each revolution. In the above example the propeller would advance 17" on each revolution. In reality, the propeller actually pushes the boat forward less distance than its pitch. The difference between the pitch and the actual distance traveled is called "slip".

Propulsion

The engine manufacturer supplies all vital information concerning your engines in the operation and maintenance manuals. Details of important engine maintenance schedules, lubrication system, cooling system and engine alert systems are outlined in these manuals. Your familiarization with this engine reference material will result in the proper usage and service that is essential for safe and enduring engine performance.

Engine Systems

Do not attempt to service any engine or drive component without being totally familiar with the safe and proper service procedures. Certain moving parts are exposed and can be dangerous.

Throttle/Shift Control

The engines throttle/shift functions are located at the helm station. The single lever used on each control box activates the gear and throttle actions.

Neutral Safety

Your outboard powered boat contains a neutral safety switch which prevents the engine from being started in gear. When starting your engine the control lever must be placed in the neutral/middle position. When functioning properly, this mechanism does not allow the engine to start when the control is not in the neutral position.

Shift

After your engine is started simply move the control lever in to the forward detent position. To place the engine in reverse, move the control lever backwards to the reverse detent location. Remember that propellers are designed for maximum forward thrust so reverse thrust will not be as efficient.

Throttle

Forward Throttle: To engage the throttle mechanism while in forward gear move the lever forward past the detent in a controlled motion. This motion will begin to increase engine RPM which will cause the boat to move forward.

Reverse Throttle: To engage the throttle mechanism in reverse, continue to move the lever forward (back or aft) past the detent in a controlled motion. This motion will begin to increase engine RPM which will cause the boat to move backwards.



Neutral Throttle: To engage the neutral throttle function on your control depress the neutral lockout button located at the center of the control lever's pivot point. While fully depressing the button inward move the control forward or reverse to activate the throttle.

Stopping

There are no brakes in a boat. It's nothing like an automobile. As a result, you have to be more diligent when operating a boat than when operating a car. You have to anticipate and avoid collisions because you do not have the option of braking at the last second. When docking and performing slow speed maneuvers, you can reverse the shift mechanism. This change in prop direction will provide some "braking action," and slow the boat.

Control Cables

If your throttle or shift cables need replacing use the same style and length as the original equipment.

Emergency Stop Switch

Your outboard powered boat is equipped with an emergency stop or "kill" switch. This is a safety feature that, if used properly, will shut the engine(s) down if the operator leaves or falls from the helm position. The standard system consists of a shut-off switch, switch clip, lanyard and lanyard clip. The



lanyard clip should be attached to the



operator. If a situation arises where the boat should stop, a pull on the cord to release the clip from the shut-off switch will shut down the engine(s). To reset the emergency stop switch, simply reinstall the switch clip. **YOU MUST WEAR THIS IMPORTANT SAFETY DEVICE AT ALL TIMES WHEN OPERATING THE BOAT.** The danger of falling out of a running boat is REAL.

This is a link to a story regarding former Miami

Dolphin football player Robert Konrad who fell off of his boat when fishing approximately 10 miles offshore: <http://abcnews.go.com/US/video-shows-miami-dolphin-rob-konrads-shock-learning/story?id=29202745>. Due to his superior physical condition, Mr. Konrad was able to swim for 16 hours in the dark and in exceptionally cold water. Most people can't do this. **WEAR THE KILL SWITCH.** We offer wireless kill switches as an option so if there is any reservation about wearing a traditional switch lanyard, ensure that you obtain and use a wireless alternative.

Steering

Steering systems require regular preventative maintenance for continued safe and reliable operation. For hydraulic helms, the oil level in the helm pump must be maintained within acceptable operating levels. A low oil level will cause air to be introduced into the steering system and result in unresponsive steering. The oil level should always be within 1/2 inch from the base of the fill hole located on the front top portion of the helm pump or remotely on the console. Check the entire steering system regularly for oil leaks (no less than every 6 months). Unobserved leaks over a period of time will



result in unresponsive steering or loss of steering. Any moving mechanical linkages, sliders, etc. should be greased as needed with high quality marine grease approved by the steering manufacturer. Refer to the manufacturer's steering manual for specific recommendations and additional maintenance. Any slow or sudden change in the "feel" of your steering system indicates an immediate need for a thorough inspection. All repairs and replacements to steering systems should be made by us or an authorized steering system dealer.

Trim Tabs

Most outboard equipped boats are equipped with an adjustable trim tab. The tab planes mounted on the transom of the boat are actuated by an electric ram piston. Two switches at the helm operate the trim tabs. The switches are labeled "bow up-bow down" and correspond to the side of the boat the switch is closest to, although the tab on the opposite side of the boat causes this motion. The trim tabs should be adjusted to balance the steering at the speed which you travel most frequently. Variations in speed, boat load or changes in the engine trim will cause the steering to pull in one direction. If the boat pulls to the left adjust the trim tab to the left and vice-versa. Always remember to fully retract the trim tabs prior to putting the boat on a trailer. Stepping on the trim tab plane may cause damage to the unit or result in injury. See the trim tab owner's manual for complete maintenance information.

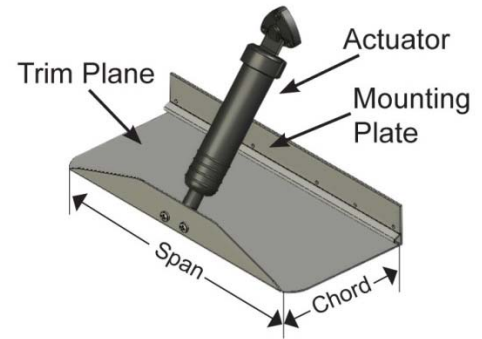

Jack Plates and Scissor Jacks

Your boat may be equipped with a jack plate or a scissor jack (also known as a Porta-Bracket). These devices raise and lower your motor in a vertical fashion, instead of at an angle like the motor's power tilt. These are excellent tools for reaching shallow water fishing grounds, but are intended for straight line and slow speed operation only. They are dangerous at fast speeds and especially in turns. If one of these devices is used to raise the motor to a point where the anti-cavitation plate on the lower unit is higher than the bottom of the boat, then then you should immediately reduce engine speed



and lower the drive until the condition is corrected. If you don't, there will be an insufficient amount of motor below the waterline which could (In addition to causing motor damage) result in your boat sliding or even spinning out of control. To minimize the risk of a slide or spin, you should always distribute weight evenly side to side and position the majority of weight in the rear of your boat. Never allow persons to sit in any area other than those specifically designated for seating, and never exceed the maximum weight printed on the capacity sticker inside your boat.

BOAT HANDLING

Before taking on passengers or a long trip, you need to learn how to handle and obtain the best performance for your boat. The best way to do that is to practice and experiment with just you on board. After several hours of operation you should experiment with throttle settings to determine the most comfortable and economical throttle range for your typical loading conditions. We suggest that you make a speed/RPM chart in order to obtain the most economical operation. Operate the boat at various speeds and check the fuel consumption at each speed. Determine the amount of operating time remaining when the fuel gauge drops to

the low fuel level. Make a log of this information and have it available when using your boat. Other statistics you should determine include the following:

- Minimum and maximum speeds for effective and safe steering.
- Turning radius at different speeds.
- Response to steering at low speeds.
- Response to steering at high speeds.
- Control of the boat using both engines in close quarters.
- Time and distance to bring the boat to a stop at different speeds.

BOAT PERFORMANCE

Maximum performance is dependent on many factors and cannot be guaranteed in every condition. These factors vary with changing conditions. These factors include:

Hull Design

The boats we manufacture are all planning hulls. This hull type has a v-shaped bottom that is designed to glide on the surface of the water (i.e., plane) as the boat gains speed. Most powerboats have this type of hull because they require less power to attain higher speeds. In the Bonefish brand we offer a variant of a planning hull known as a stepped hull. Steps are essentially elevation breaks in the hull bottom that create multiple running surfaces. As the boat increases speed, the hull rides on these surfaces, with the area that is in contact with the water moving progressively aft and reducing in size. This results in more speed with less power than a conventional planning hull. Stepped hulls aren't for everyone. They demand a higher level of skill and attention by their operator. They are NOT for novice boat operators. They have limitations in trim capability that don't allow operators to dictate the boat's attitude (i.e., "fly" the boat) with complete autonomy/independence using tabs and engine trim (They tend to ride at a particular attitude based upon the hull's design with reduced ability to effect pitch and yaw). Stepped hulls are also much more sensitive to weight. Heavier weight greatly effects the ability of a stepped hull to reach its designed efficiency. Weight additions (particularly up high) also present the risk of excess chine immersion (sinking the step vents below the water line) which blocks air flow to the steps and can result in a low-pressure spike that causes a loss of directional control. For these reasons, the operator of a stepped hull must pay close attention to the weight limitations provided with the boat. To the extent weight is added to the boat, you must distribute it evenly from port to starboard, mostly in the stern and as low as possible in the hull. If a tower or other elevated driving station is offered on a stepped hull boat, it is the only elevated station we believe is safe for a recreational boater. Do **not** purchase a tower or other elevated driving station from someone other than us for your step bottom boat. Metal fabricators know absolutely nothing about hydrodynamics or what impact their creations can have on a boat's center of gravity. They create unnecessary risks for the operator. Considerable time should be spent by the boat's operator learning the boat's handling characteristics and experimenting with weight distribution prior to taking passengers onboard and being responsible for their safety. There is absolutely no substitute for time behind the wheel.

Engine Efficiency

Engines operate most efficiently at the RPM confirmed in the engine operating manuals, assuming your boat is equipped with the correct engines, the engines are properly tuned and the drive systems are in good condition. Efficiency will decrease if normal care and maintenance is not performed. If engines are neglected power will drop and speed will decrease. In addition,

expensive repairs may become necessary. Be sure to follow all instructions in the engine operation manuals.

Weather Conditions

Weather conditions affect engine performance. Barometric pressure and humidity both influence horsepower. A change of weather could cause a 10% loss in horsepower on a hot day.

Marine Growth

Maximum performance is obtained only when your hull bottom is clean. Marine growth on the bottom of the boat will increase resistance and decrease speed. These conditions will also increase fuel consumption.

Sea Conditions

Sea conditions vary a boat's performance greatly. You will need to slow down and operate the boat more conservatively in higher seas.

Load and Load Distribution

A drastic change will be noticed when gear, equipment, passengers and fuel are added to the boat. The smaller the boat, the more drastic the change. This extra load and its placement greatly affect performance and handling. Water accumulation in the bilge and/or baitwells also impacts



This is Incorrect

performance. Keep the bilge dry and drain all wells when not in use. To minimize the risk of a slide or spin, you should always distribute weight evenly side to side and slightly more in the rear than the front. Never allow persons to sit in any area other than those specifically designated for seating, never let them stand when the boat is underway and never exceed the maximum

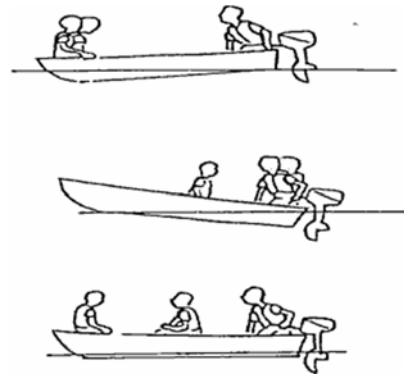

The Bottom Figure is Correct

weight printed on the capacity sticker located inside your boat. It will cause the boat to become tippy and unresponsive. This video

demonstrates what we mean (forgive the colorful language – it's not our video): https://www.facebook.com/BonefishBoatworks/videos/1596884063692576/?hc_ref=ARQD5JzjsjdNO_YLp4b1BkfC2xLJ4KnFQy1MK99PXN6nQOW412bFkcazFrOej_VUiOo&fref=nf. Trust us, this can happen on your boat too. Water is not land and boats do not respond to weight the same way a vehicle does. Don't think you "know" what to expect. Maintain a safe distance. Practice operating your boat and take a safe boating or captain's course. They're worth the time and money. They may save a life in addition to preserving your property.

HAZARDS AND WARNINGS

This manual includes several safety instructions to assure the safe operation and maintenance of your boat. These instructions are in the form of DANGER, WARNING, CAUTION and LEGAL statements. These hazard warnings shown below are used in this manual to alert you to potentially dangerous situations that can lead to breaking the law, product damage, personal injury and/or death. We urge you to observe these warnings and to comply with all safety recommendations.



Loading and Horsepower Capacity

As already discussed, overloading and improper load balancing causes many boating accidents. Boaters must know the amount of weight on board and evenly distribute that weight within the boat. There is a capacity label affixed in the boat. Know your boat's maximum capacity and maximum horsepower and never exceed those limits.

U.S. COAST GUARD MAXIMUM CAPACITIES XX PERSONS OR XXX POUNDS
XXX POUNDS, PERSONS, MOTOR, GEAR XX HORSPOWER MOTOR
THIS BOAT COMPLIES WITH U.S. COAST GUARD SAFETY STANDARDS IN EFFECT ON THE DATE OF CERTIFICATION (Company Name and Address)



Turning

Turning a boat in any condition other than calm seas with no wind and a single occupant with the lower unit of the motor fully in the water can be dangerous. Turns can result in shifting or throwing persons or cargo overboard...or even worse, capsizing. Extreme caution must be exercised when executing turns any faster than minimum planning speed (typically around 20 mph for vessels over 16' in length) and should be as wide as possible to avoid slipping on the water's surface or hooking an edge that could cause a boat to turn abruptly with a violent change in



direction. You should have one hand on the wheel and the other on the throttle at all times so that you can quickly make adjustments to both while executing the maneuver. **Never** jerk the steering wheel. A well-executed turn requires a steady hand. **Never** attempt a turn if: (i) the lower unit of the motor is not fully under water; (ii) you are traveling faster than minimum planning speed; (iii) the boat is overloaded; (iv) the boat's load is not evenly distributed from side to side and positioned mostly in the rear of the boat; or (v) passengers are not fully seated in designated seating areas.



Skiing, Wake Boarding, Surfing, Knee Boarding and Similar Water Sports

Our boats are all equipped with outboard power. As a result, extra caution must be used when participating in water sports. If your boat did not come equipped with a ski pylon, then you must use a Turbo Swing or tow bridle when pulling skiers, wake boarders, knee boarders, tubers and other water sport participants. A distance of 100 feet from the boat's propeller is the bare minimum distance you should maintain when engaging in water sports activities. **Never** allow wake surfing or skurfing (close to boat slow speed board planning) behind an outboard powered boat. The participant is at risk of carbon monoxide poisoning as well as serious injury or death if they fall onto or near the spinning propeller. An outboard creates significant suction aft of the motor that it can pull a person into the spinning propeller or even under the boat. Finally, the most important thing to remember is to keep a



Turbo Swing



Tow Bridle



safe distance from objects in the water that could impair or alter the performance of the boat or the water sport participant (e.g., shallow water, docks and other boats). You must employ a human spotter to watch the water sport participant(s) at all times and communicate with the boat's operator. Also, when retrieving people, turn the motor off and pull them in by the towline.



Propellers

It should go without saying that propellers on a boat are exceptionally dangerous...but we're saying it anyway. It's a large metal hub with sharp blades spinning rapidly. Think of it as an unguarded food processor blade. Knowing this, always exercise extreme caution and good judgment regarding propellers and at a minimum, follow these simple rules:

- 1) Never allow people to sit on the deck of the boat when the propeller is engaged (Any deck mounted seat backs provided by Bonefish are for use at rest only);
- 2) Turn off your motor whenever you are around swimmers;
- 3) Turn off your motor if anyone is on your boat in any a position other than fully inside the boat in a designated seating area;
- 4) Turn off your motor if anyone is using or is about to use a swim ladder; and
- 5) Advise all occupants of the dangers associated with a propeller on each trip.

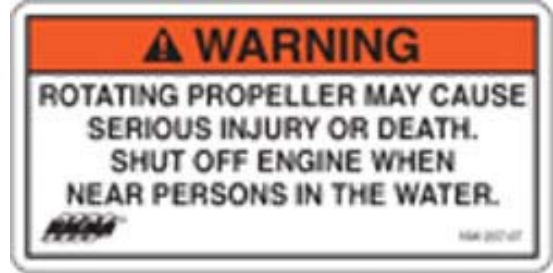

Fueling

Safety during fueling requires CAUTION and COMMON SENSE. Observe the following precautions carefully:

- Check your engine manual to confirm the type of fuel and oil specified by the manufacturer. Do not use fuel containing alcohol. Alcohol in fuel will deteriorate the rubber material used to make up your fueling system.
- Have an adequately charged fire extinguisher nearby.
- Observe all safety regulations for the handling of fuel.
- Extinguish cigarettes and all other lighted materials.
- Before fueling shut down all engines.
- Before fueling close all ports, hatches, windows, and engine compartments to prevent fumes from accumulating in closed areas.
- Before fueling turn battery select switches to the "OFF" position to insure that all lights, electronic equipment, etc. are off.
- Keep the fuel supply nozzle in contact with the fuel tank opening to prevent any static sparks.
- Do not over fill tank. Wash and clean-up any spilled fuel. Secure the fuel cap and check fuel lines and connections for leakage.
- Dispose of rags or sponges used for clean-up on shore. Do not store these clean-up rags in the boat.
- After fueling ventilate all ports, windows, hatches and other closed areas.
- Conduct a "sniff test" to make certain all fumes are vacant before using the battery select switches.



Carbon Monoxide

Exhaust fumes contain carbon monoxide (CO), an odorless and colorless gas. Carbon monoxide is poisonous and a health hazard that can be fatal if breathed over an extended period of time. Symptoms of CO poisoning can include:

dizziness, nausea, headache, sleepiness, vomiting, throbbing in temples, muscular twitching and the inability to think clearly. If you or anyone else experience these symptoms immediately get away from fumes and into an area where plenty of FRESH air. If symptoms persist seek medical attention. Carbon Monoxide (CO) is the gas formed by the combination of one molecule of carbon and one molecule of oxygen. Chemists refer to it as CO. The boat operator should be aware that CO is emitted from any boat's exhaust. You are susceptible to CO while operating, mooring, and or anchoring in an area containing other boats emitting engine exhaust. An operator, likewise, needs to be aware of the consequence of his actions on other boats. Of primary concern is the operation of an auxiliary generator with boats moored alongside each other. When operating center console or dual console boats at cruising speeds, slow speeds, or dead in the water with canvas tops, side curtains and or back curtains in place, be aware of engine exhaust to ensure that emissions do not accumulate in the boat's interior. Maintain proper ventilation by adjusting canvas enclosure.

⚠ WARNING	
	<p>Carbon monoxide (CO) can cause brain damage or death.</p> <p>Engine and generator exhaust contains odorless and colorless carbon monoxide gas.</p> <p>Get fresh air if anyone shows signs of carbon monoxide poisoning.</p> <p>Signs of carbon monoxide poisoning include nausea, headache, dizziness, drowsiness, and lack of consciousness.</p> <p>See Owner's Manual for information regarding carbon monoxide poisoning.</p>



Discharge Regulations

The Federal Water Pollution Control Act prohibits the discharge of oil or any other hazardous substances which may be harmful into the U.S. navigable waters. The US Coast Guard requires any vessel 26 feet or greater display a placard in a prominent location notifying the crew and passengers of discharge restrictions. Each placard must be at least nine inches wide and four inches high, made of a durable material and printed with letters that are at least 1/8 of an inch in height. Violators are subject to a penalty of \$5,000. The placards are available online and in most boating supply stores. A sample placard appears below:

<p>THE DISCHARGE OF COOKING OIL, PLASTIC, INCINERATOR ASHES OR GARBAGE WITH PLASTIC INTO ANY WATERS IS PROHIBITED. THE DISCHARGE OF ALL GARBAGE IS PROHIBITED IN THE NAVIGABLE WATERS OF THE UNITED STATES AND IN ALL OTHER WATERS, WITHIN THREE NAUTICAL MILES OF THE NEAREST LAND.</p>		
<p>ALL DISCHARGE OF GARBAGE IS PROHIBITED IN THE GREAT LAKES OR THEIR TRIBUTARY WATERS.</p>		
<p>THE DISCHARGE OF NON-PLASTIC GARBAGE, DUNNAGE, LINING, AND PACKING MATERIALS THAT FLOAT IS PROHIBITED WITHIN 25 NAUTICAL MILES FROM THE NEAREST LAND.</p>	<p>THE DISCHARGE OF OTHER UNGROUND GARBAGE IS PROHIBITED WITHIN 12 NAUTICAL MILES FROM THE NEAREST LAND.</p>	<p>THE DISCHARGE OF OTHER GARBAGE THAT IS GROUND TO LESS THAN ONE INCH IS PROHIBITED WITHIN 3 NAUTICAL MILES FROM THE NEAREST LAND.</p>
<p>ANY PERSON WHO VIOLATES THE ABOVE REQUIREMENTS IS LIABLE FOR CIVIL PENALTY AND POSSIBLE FINE OF UP TO \$500,000 AND IMPRISONMENT FOR UP TO SIX YEARS FOR EACH VIOLATION. OTHER REGIONAL, STATE, AND LOCAL RESTRICTIONS ON DISPOSAL OF GARBAGE MAY ALSO APPLY.</p> <p>REPORT ILLEGAL DISPOSAL TO THE U.S. COAST GUARD ON VHF RADIO 16.</p> <p style="font-size: small; text-align: right;">bereng.com</p>		



Disposal of Plastics and Other Garbage

The US MARPOL ANNEX V is the Act to prevent pollution from ships and other vessels. Federal regulations prohibit the discharge of plastic garbage anywhere in the marine environment. Plastic includes but is not limited to: synthetic fishing nets, ropes, lines, straws, six pack holders, Styrofoam cups and lids, bottles, buckets and plastic bags. These regulations also restrict the disposal of other types of garbage within specified boundaries from shore. The following plaque will help you determine the specific distances offshore that certain garbage is permitted.

BEFORE HEADING TO THE WATER

Federal and State laws require power boats and trailers to be registered in the state where they are primarily used. Registration numbers and validation stickers must be displayed according to applicable regulations. The registration certificate for the boat must be on board when boating. The boat Hull Identification Number (HIN) is required on the registration form. The "Hull Identification Number" is located on the transom of your boat, typically on the starboard side.

TRAILERING YOUR BOAT

Never allow passengers to ride in the boat while trailering. Check brakes prior to leaving. Drive as steady as possible and avoid sudden jerks. Anticipate stops to make them smooth. Road trips call for occasional stops to make sure the trailer is still secured properly. The adjustment and balance of your boat on the trailer determines how easily your boat may be transported. The tongue weight on the hitch ball should be 5-10% of the total weight of your boat, motor and trailer. Tail-heavy loads cause swaying while trailering. The rollers and/or bunks of your trailer should be adjusted so that the weight is distributed evenly across the stern and forward throughout the keel sections. Practice maneuvering the trailer. The trailer always backs in the opposite direction of the vehicle: To maneuver the trailer, turn the steering wheel in the direction you want the trailer to go. This is a good checklist to follow when trailering your boat:

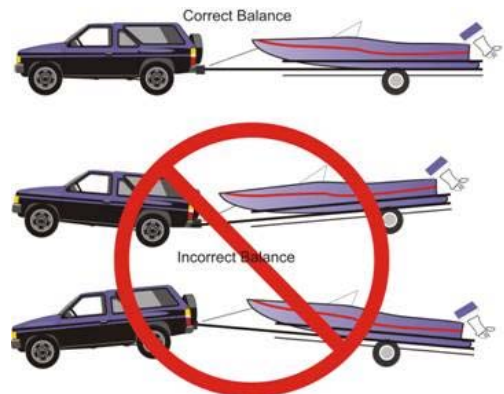

- Consult your state laws as to brake and axle load requirements.
- Check brakes for proper operation and fluid level prior to departure on each trip.
- Check springs and undercarriage for loose parts.
- Check tires for proper inflation. Under-inflated tires heat up rapidly and tire damage or failure is likely to occur.
- Wheel bearings and lug nuts should be checked before each trip.
- Your boat should be fastened to the trailer by a line from the bow eye to the winch line plus a bow tie-down to the winch stand or trailer tongue. The stern of your boat should be tied down to the trailer from the stern eyes.
- Check to be sure the tail lights and turning signals work prior to towing.
- Bimini tops are not designed to stay on boats at highway speeds.
- Before towing, take down the Bimini top, if equipped.
- Carry a spare tire for both your trailer and your towing vehicle along with sufficient tools to change them.
- Be sure all lids, doors, and the engine cowling are latched securely before trailering.
- On extended trips, carry spare wheel bearings, seals and races.

- While traveling, check the wheel hubs every time you stop for gas or refreshments. If the hub feels abnormally hot, the bearing should be inspected before continuing your trip.
- When rounding turns on highways or streets, do not cut corners. Also, go slowly over railroad tracks.
- Before backing your trailer into water, disconnect the light plug from the towing vehicle to reduce the likelihood of blowing out lights when they become submerged.

PRIOR TO LAUNCHING YOUR BOAT

Below is a list of items to check and perform prior to placing your boat in the water:



- Check all gear and replace if necessary
- Check thru hull fittings for cleanliness, damage and tightness.
- Check prop installation and tightness.
- Clean battery terminal posts with a wire brush or bronze wool.
- Install batteries, attach cables and tighten. Apply grease to post to exclude air and acid. Check all wire connections for contact corrosion and tightness.
- Check hull valves for easy operation and for condition of hose.
- Check operation of bilge pumps in manual and automatic modes.
- Check shower sump pump. Check operation of all DC circuits if applicable.
- Check the hose and lines on the fresh water system, install drain plug and close drain valves.
- Perform maintenance on engines according to the manufacturer's manuals prior to returning them to service.
- Fill fuel system and thoroughly check out fuel system including lines, fittings, connections, valves and filters for leaks.
- Check operation of toilet (reference manufacturer's manual).
- Check all engine and steering control cables and linkage for operation.
- Lubricate cables and linkage as necessary.
- Fill fresh water system and check for leaks.
- Check safety equipment including flares, fire extinguisher and first aid kits. Replace items as necessary.

PRE-START CHECKLIST

The following checks are essential to safe boating and should be performed before ever starting the engine. Get in the habit of performing these checks in the same order each time so that it becomes routine.

- Ensure weather conditions are (and are predicted to remain) conducive to safe operation. Never operate your boat during small craft advisories or worse weather conditions.
- Check that the required safety equipment is on board and in good condition.
- Check that the fire extinguisher is fully charged, and be sure that you are familiar with its proper use.
- Check that no fuel, oil or water is leaking.
- Check all hoses and connections for leakage and damage.
- Check that the hull drain plug is in place and securely tightened before putting the boat in the water.
- Check that battery terminals are clean and tight.

- Check that all navigation lights operate properly.
- Check that fuel and oil levels are adequate. Always carry more fuel than you anticipate using, in case you are forced to change your plans for weather or other reasons.
- Check that throttle/shift control is in neutral.
- Check that the steering system operates properly.
- Check that all required maintenance has been performed.
- Check to ensure the anti-cavitation plate on the lower unit of the motor is lower than the water line.
- Verify that all weight loaded into the boat is distributed evenly from side to side and positioned mostly to the rear of your boat.
- Do not allow people to sit in any area other than those specifically designated for seating.
- Verify that the combined load of passengers and cargo do not exceed the maximum weight printed on the capacity sticker inside your boat.

LAUNCHING

Be sure to look in all directions before backing down a boat ramp. You'll need to verify that the drain plug is in and that there are no stern straps holding the boat to the trailer before backing into the water. While it may be possible to launch your boat without the use of a concrete ramp, be sure that your chosen spot is legal and won't result in your vehicle or your trailer becoming stuck in sand or mud. After backing down the ramp stop backing into the water once the boat begins to float/lift off of the trailer. While there is no hard and fast rule for all trailers on all ramps, submerging the lower half of the trailer fender is usually pretty close. Make note of the correct depth for future reference.



Before exiting the vehicle to launch the boat be sure the vehicle is turned off and the parking brake is engaged. For manual shift vehicles, be sure to also leave the vehicle in gear. Take a close look at these photos. Clearly these boaters didn't make sure their vehicles were in park and the break was fully engaged. Don't let this happen to you. Another common mistake is launching the boat before tying a line to the forward and stern cleats. If you do that, you'll have to depend upon the generosity of a fellow boater, an incoming tide or your swimming proficiency to retrieve your boat.



NON-RAMPS

You can, in some situations, launch and retrieve a boat safely without using a traditional paved boat ramp. If you intend to do so be aware that it can be very difficult. Traction is typically lost on loose sand and rocks. Use of a four wheel drive vehicle is highly recommended. Ensure that you are not on private property without permission or on government property that is restricted in use. Finally, be sure to check the tides. I'm sure this spot was perfect when he launched the boat, but it obviously isn't now that it is time to go home.



IMMEDIATELY BEFORE AND AFTER LAUNCHING



Before releasing the boat from the trailer and/or the dock inspect the boat for all sources of possible leaks from stem to stern (including the bilge area). Verify that all engine and steering control cables and linkage are lubricated and have been properly maintained for safe operation. Ensure all motor bolts are tight and ready for use. If any of these critical items are not functioning in accordance with the manufacturer's design immediately contact a service facility to schedule a thorough inspection and service. Always operate your engine(s) as directed in manufacturer's manual.



RETRIEVING THE BOAT FROM THE WATER

If you were paying attention when you launched the boat, you'll know how deep to submerge the trailer in order to pick the boat back up (assuming the tide hasn't changed too much in the meantime). Your trailer should be equipped with a safety chain. You should hook the chain to the bow eye every time you pull the boat anywhere...especially out



of the water. This one is worth repeating because so many people mess it up. ALWAYS USE A SAFETY CHAIN WHEN TRAILERING A BOAT. Winch straps are pretty strong, but they fray and decay over time. If these guys had used their safety chains they could have avoided some very expensive fiberglass repairs.



STERN STRAP THE BOAT WHEN IT IS ON A TRAILER



In addition to being the law in most states, using a stern strap on your boat when it is on a trailer is just good common sense. Even people with a rudimentary understanding of physics realize that a boat will not stay on a trailer during a sharp turn or over a large bump in the road if the stern is not



strapped down. What usually happens is the strap is broken or forgotten and people “risk it”. They’re often reminded the hard way of what happens if you chance it. Hopefully the folks in these photos have learned their lesson.

TRAILER MAINTENANCE

Trailers don’t maintain themselves. Read your owner’s manual and contact the manufacturer if you don’t have one or it’s misplaced. Follow their guidelines religiously. At a minimum, you should check for sufficient grease in the hubs every time you move your boat. Bearing buddies are available at trailer and marine supply stores to make it easier to apply grease to trailer hubs. You should also make a visual inspection of your suspension to see if there are any loose fittings. Your axle(s) should be serviced and properly lubricated, and all fasteners checked and tightened at least once a year. These guys failed to maintain their trailers and it caused the hubs to rot off of the axle. They’re lucky that this is all that happened. Imagine if they had been traveling 60mph in rush hour traffic. Significant property damage and personal injury would have resulted. Trailer maintenance is serious business.



OPERATING YOUR BOAT

Leaving/Approaching the Dock

Unlike an automobile, the stern of your boat reacts first when turning. A turn to the right will swing the stern to the left and vice-versa. Remember that turning your boat away from an object such as a dock will tend to swing the stern toward that object.

Rules of the Road

Boat operation is governed by the International Regulations for the Prevention of Collisions at Sea 1972 (72 Colregs) and the 1980 U.S. Inland Navigation Rules (Inland Rules), also known as the Rules of the Road. You may also be responsible for any local regulations (rules that elaborate on minor details of the Inland Rules). The boundaries between the 72 Colregs and the Inland Rules are indicated by a dashed magenta line (demarcation lines) on navigational charts. We have included a portion of the Rules of the Road in this manual, but they are not intended to be your sole source of information.

Overtaking

The boat that is overtaking one ahead of it is the burdened boat and must make any adjustments necessary to keep out of the way of the privileged boat.

RULE 13: OVERTAKING



Meeting Head-On

Neither boat has the right-of-way in this situation. Both boats should decrease speed, should turn to the right, and pass port-to-port. However, if both boats are on the

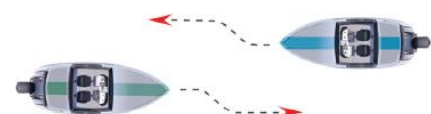

left side of a channel, each vessel should sound two short horn blasts and pass starboard to starboard.

Privileged Boats

Privileged boats have right-of-way and can hold course and speed. Sailboats and boats paddled or rowed have the right-of-way over motor boats. Sailboats under power are considered motorboats. Small pleasure craft must yield to larger boats. However, you must use common sense when applying these rules. Not everybody follows the rules. Boating is no different than driving. You must be defensive. Anticipate potential collisions and avoid them. One area often neglected by power boat operators is the danger associated with slowing down or stopping. Boat's don't have taillights, so you must be aware of and avoid collisions with any boats traveling behind. A sudden slow down or stop could result in a serious accident.

Burdened Boats

A burdened boat is the boat that must make whatever adjustments to course and speed necessary to keep out of the way of a privileged boat.

Crossing Situation

In crossing situations, where two power boats meet, the boat to the right from the 12 o'clock to the 4 o'clock position has the right-of-way. It must hold course and speed. The burdened boat keeps clear and passes behind the privileged boat. Power boats going up and down a waterway have the privilege over power boats crossing that waterway.

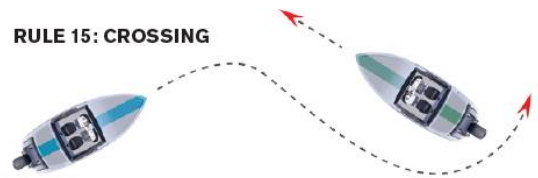

The General Prudential Rule

The general prudential rule regarding right-of-way is that if a collision appears unavoidable, neither boat has the right-of-way. **Both** boats must act to avoid a collision.

Slow Down In Unfamiliar Areas

Common sense should tell you to slow down if you don't know the area. You can damage your boat at almost any speed, but the damage will be much less when you're slow and in control. This guy shattered his boat into a million pieces at high speed when he didn't know where he was going. Chart plotters/GPS units are great aids to navigation, but they are not always accurate. There is no substitute for the operator's vision. Be in control and keep a watch full eye out.



Weather

Inclement weather is a major contributing factor to boating accidents. **Never** operate your boat in anything other than clear skies without rain, fog or a small craft advisory. This photo is of a boat that traveled across a sandy beach and hit a restaurant when the operator got lost in foggy conditions. This is a link to an article describing



the accident: <http://www.tbo.com/south-shore/boat-crashes-into-ruskin-restaurant-20150223/>. Don't let this happen to you. If you have electronic navigation aids, use them...but remember they're no guarantee that there are unknown objects that you can't see. Slow down and give yourself time to make adjustments.

Sea Conditions

Know the seas you are operating in and slow your rate of speed to stay in control at all times. Never operate any boat during a small craft advisory...ever. If you have an inshore boat, it is not intended for operation in greater than 1' seas or 3 kt winds, or more than 1.5 miles from shore. Obey the maximum sea and wind limitations described at the beginning of this manual. The term "sea



conditions' doesn't refer only to open water. It covers the weather and the location where the boat is operated, including in a pass/inlet or along a beach. Some of the most difficult water to navigate can be an inlet or pass due to the deep water, cross winds and excessive waves. This is a link to a video showing just how difficult it can be to operate a boat in those conditions:

<https://www.google.com/search?q=google&ie=&oe=#q=jupiter+inlet&tbm=vid>. No boat is intended for operation in the surf. This is a photo of a boat that capsized near shore because it was operated in the surf. This is a link to alarming video of another boat doing the same thing: <https://www.youtube.com/watch?v=Cjsnqh49KDC>.

Using Your Boat At Night

Nighttime operation is exceptionally dangerous. At night it is **impossible** to see hazards and your depth perception is severely altered. Your boat is intended for daytime recreational use only...**not** nighttime operation of any kind. Numerous hazards, such as unmarked



boats, aids to navigation and floating debris, put you and



your passengers at risk. To operate a boat safely in the dark requires extensive training, sophisticated equipment (e.g., chart plotters, radar, satellite navigation and night vision cameras), a thorough knowledge of the water being navigated, a slow rate of speed and multiple persons serving as look outs. People die and are severely injured in nighttime accidents. This article describes a nighttime accident that led to the premature death of two promising pitchers in the Cleveland Indians organization:

http://www.cleveland.com/tribe/index.ssf/2013/03/a_look_back_indians_pitchers_k.html. By law, boats operating between sunset and sunrise must use navigation lights, so we equip your boat with them....but we do not authorize or condone the operation of your boat at night. If you

disobey this restriction, you do so at your own risk and the Rules of the Road still apply. You should slow down to idle speed and stay clear of all boats and other obstacles, regardless of who has the right-of-way. Protect your night vision by avoiding bright lights and have passengers use search/spotlights to help watch for other boats, hazards, and aids to navigation.

Anchoring

Several factors determine the size and type of anchor most suitable for your boat, including the boat's size and the type of bottom in your boating area. **Never** anchor off the stern of the boat, and never try to retrieve an anchor by using the boat's motor to create leverage. It's easy to have water pour over the sides of the boat and swamp it. The photo at right is of Nick Schulyer who was the sole survivor of a four man fishing excursion that ended with a capsized boat because of stern anchoring. This is a link



to an article describing the horrible events and how it could have been easily avoided: <http://www.tampabay.com/blogs/media/content/boating-accident-survivor-nick-schulyer-shares-awful-details-hbos-real-sports>. If desired, anchoring can be made less difficult by equipping your boat with a windlass system. A windlass can be operated by switches mounted at the bow or from a rocker toggle in the switch panel at the helm. You'll need to consult the windlass operation and service manual for further details.

Extended Stay

If you decide to camp out or leave your boat anchored in open water for an extended period of time, be sure to anchor securely and make allowances for tides and wave action...if you don't you may wake up to something like this.



Shallow Water

Most boats that become grounded can be floated off with motors tilted to reduce the draft at the transom. Do not attempt to power off if the propellers are in mud or sand due to possible damage to your engine's cooling system. With motors tilted, try rocking the boat from side to side to break the suction of mud from the keel. Move passengers or heavy objects away from the point where the boat is grounded. Do not lower or start the engines until the boat is clear of the ground. When boating in water with tidal changes be mindful of fluctuations of the water level. If you are grounded on an incoming tide you can wait until the tide is high enough to re-



float your boat. However, with an outgoing tide take quick action to re-float your boat. If this is not possible set an anchor to keep the boat from being driven further aground and to counter the action of the wind or current. The anchor, in some cases, can also be used to pull the boat free. Many inland areas have rocks and stumps which could crack or puncture a fiberglass hull. Be familiar with the boating area and use caution in shallow water. Remember that in saltwater, you have to account for tides. Just because you were able to navigate an area without issue once doesn't mean you can again. This photo is proof of that.

Tower Boat Operation

Some boat models are equipped with towers (sometimes referred to as upper driving stations). Extreme caution must be exercised when operating a tower boat. Towers elevate the center of gravity in a boat upward from its original location slightly above the water line. As a result, the boat becomes more “tippy” than when it wasn’t equipped with a tower. Extra caution should be paid when taking a tower boat into seas larger than 2”. Rollover and capsizing are highly likely if the boat is not operated properly. A tower boat should never be operated by a person who is not a licensed captain. Under no circumstances should a boat be operated with a tower that was not constructed and installed by Bonefish Boatworks. If Bonefish does not offer a tower option, that means we do not believe the boat is safe to operate with a tower or upper station under any conditions. Don’t take one of our boats to a metal fabricator to have a tower installed. They have no idea what impact their creations can have on a boat’s center of gravity, displacement and/or operating characteristics.



Navigation

We cannot stress enough the importance of knowing where you’re going. If it’s a new area, go slow until you understand what obstacles exist. A good GPS, charts and chart plotter are all important tools to help prevent an accident and save your life, but they are no substitute for good judgment. This photo is of a boat accident that killed Miami Marlins pitcher; Jose Fernandez. As you can see, the boat hit a rock jetty that the operator could not see but was plainly marked on all charts of the area as well as on all chart plotters. When the boat hit the jetty it threw the occupants out and killed them. This is a link to a story about the accident: http://live.tampabay.com/Event/Marlins_ace_Alonso_grad_Jose_Fernandez_dies_in_boating_accident?Page=2.



Changing Conditions

Familiarity with an area doesn’t guarantee that it hasn’t changed since the last time you were there. Debris is a constant challenge and structures can be erected that are not yet shown on charts or chart plotters. Sometimes fog can cause you to misjudge distance and location. Tide changes definitely impact navigation. Just because you can travel in an area at high tide doesn’t mean you can at low tide. The owner of this boat learned that lesson the hard way.



Drain Plugs

If you’ve owned a boat long enough, you’ve likely launched once or twice without installing the drain plug(s). It makes for a hectic and stressful time on the water, if not a deadly or highly damaging one. Always check the drain plug before placing the boat in the water. They age and deteriorate. It’s your responsibility to make sure yours works.

Sinking

A large number of boats sink every year because of either poor maintenance (failing to regularly check your plumbing for leaks and



replacing aging hoses and fittings), improper tying off and rainfall. You must account for rising and falling tides whenever you tie off or anchor your boat. If you tie your boat too tight to a dock, it will heel over as the tide goes out. If your boat is tied too loose, then it can get trapped under a dock when the tide rises. It's always best to use a spring line. If you don't know what that is,



then you definitely haven't taken a boating safety class or done the reading required by this manual. If at all possible, try to use a slip instead of just tying off to one side (as was done in the photo). It's much easier to avoid accidents by tying off in a slip than it is on a straight dock or sea wall. Learn how to properly tie up your boat! You must also be aware of changing weather. In tropical areas it's not unusual to have extraordinarily heavy rains. Near shore and offshore boats are typically designed with self-bailing decks. That means you do not need a pump to remove water from the deck...but it doesn't mean you can dock your boat and forget it. A typical gravity fed 1.5" drain can only drain 35 gallons of water per minute. Your boat may have only

one or two such drains in the deck. A boat can collect considerably more water than that in a heavy rain storm. When this happens the excess weight (water weighs 8lbs per gallon) can force the deck drains below the waterline. This causes water to flow from outside to the inside of the boat and cause it to sink. As a result, you should never leave your boat unattended in the water without a cover that keeps rainwater from accumulating inside.

Youngsters

We'd all like to think that our children can safely operate a boat. The truth is that they probably can...in unchallenging conditions. The problem is that they're training, intelligence and life experiences are insufficient to handle anything other than flat calm sea conditions with no boats or navigational obstructions around on a day with no unexpected events. If only life could be that carefree. Since it's not, people without a valid unrestricted automobile driver's license and a safe boating certificate should not operate the boat. If the person is under the age of 18, they should be directly supervised by an adult onboard at all times. A motor vehicle driver's license does not prepare a person for boat operation, but it is indicative of the maturity and responsibility necessary to operate a moving vessel safely. Moreover, the



requirements for operating a motor vehicle teach youths to avoid panic when hazards and unexpected conditions arise. These lessons easily translate to the water. Notice that in addition to sinking the boat, the kids in this photo didn't wear their life jackets. You can almost hear them saying they are "fine" or "it was no big deal". They're so inexperienced they're incapable of determining what a "big deal" is. You're the adult, so act like it.

Careless Driving

Take the time to learn your boat and its handling characteristics in all sea conditions. Do not take extreme angles or make sharp turns (as seen in this photo). It can cause harm to occupants and cause the boat to change its running surface which results in unpredictable handling. In this photo for example, a turn is being performed so sharp, that the sides of the hull are actually touching the water. This may look “cool”, but boats are designed to ride on the bottom surface, not the sides. This is never safe. You wouldn’t attempt to drive a car on its side, so don’t do it in a boat.



Pay Attention

Regardless of sea conditions, weather and visibility, the most important thing you must do when operating a boat is to pay attention. Obstacles, boats and even aids to navigation can creep into the boat’s path if you aren’t watching where you’re going. This video is an excellent example of what can happen when you’re not paying attention: https://www.youtube.com/watch?v=Z_rONiiSrmc.



Trolling Motors

Your boat may be equipped with a trolling motor. A trolling motor has a fixed length shaft that is lowered into the water and provides quiet electric propulsion in shallow water conditions. It is incumbent upon the operator to ensure that the depth at which the motor is set is sufficient for safe operation and will not result in jamming the shaft if it runs aground or worse, bending or breaking the shaft. The owner of the boat in this photo didn’t properly adjust the depth of his trolling motor and it was ripped right off of the front deck of the boat when a wake caused by a fellow boater picked the boat up and set it back down. Not only was the trolling motor broken, the incident resulted in a nasty and expensive fiberglass repair. Also, always store the trolling motor with the depth control collar all the way down the shaft as close as possible to the base. This way the motor will be unable to deploy if you fail to properly engage the locking base or you experience a failure in the base. Finally, you should purchase and install an isolator mount for the motor head. It will keep the trolling motor from bouncing when you go over waves which in turn leads to premature failure.



BOATING SAFETY

Safety is an important aspect of boating. Proper operation and maintenance will ensure quality performance and longevity of any boat. Remember, your safety and the safety of your passengers is your responsibility.

Precautions

The following precautions will help you be a safe boater.

- Study all operation and maintenance manuals for the equipment on the boat before operation. Contact us with any questions or concerns.
- Leave a written float plan with a reliable person. It will [provide valuable information if you have a mishap and do not return on



time. Upon returning notify the holder of the float plan to prevent false alarms about your safety.

- Never operate or allow anyone else to operate your boat while under the influence of drugs or alcohol.
- Do not allow inexperienced persons to operate the boat without constant and direct supervision.
- Ensure that the person piloting your boat is familiar with basic boating techniques and safe operation in the event of an emergency.
- While boating, passengers should be settled in a safe position. Do not allow bow-riding, transom or gunnel riding.
- Keep your boat speed under control. Respect for other boaters and those onshore is not only common courtesy, it's the law. The operator of a boat is responsible for any injury or damage caused by the boat's wake. Your wake could swamp or damage a smaller craft or endanger its passengers. Stay alert for posted "No Wake Zones".
- If your boat is equipped with a boarding ladder never attempt to use it while the engine is running. A shift lever in the neutral position could accidentally become engaged causing severe harm to swimmers. Your boarding ladder is designed for use by persons boarding the boat from the water. Do not use the boarding ladder while the boat is out of the water. Damage to the boat and/or ladder could result.
- Do not operate your boat in swimming or diving areas at any time. Serious injury or death could occur from the rotating propeller blade.
- Use extreme caution whenever swimming near the boat, even when the engine is off. A propeller will tend to rotate if subject to a current and could cause serious injury or death.
- When venturing into unknown waters collect information on the boating area. Obtain charts for new areas whenever possible.
- Use boat shoes or tennis shoes to reduce the risk of slipping or falling.

Required Safety Equipment

The US Coast Guard (USCG) requires every boat to have specific equipment on board. Check with local regulations on mandatory equipment apart from the following list of Coast Guard requirements:

PERSONAL FLOTATION DEVICE (PFD)

You must have a USCG approved personal flotation device of Type I, II, or III aboard for each passenger, in addition to one Type IV throwable PFD. All occupants of your boat should wear a PFD at all times. In some jurisdictions, children are required to wear a PFD. Check your local regulations for any other applicable requirements.

FIRE EXTINGUISHER

At least one Type-1 hand held portable fire extinguisher must be carried on board. For boats over 20' two are required. Check your extinguisher regularly for charge status.

SOUND SIGNALING DEVICE

Your boat should have a horn, whistle or some other device which meets the USCG requirements for a sounding device.



VISUAL DISTRESS SIGNALS

USCG approved visual distress signals are required for day and night use when operating in US waters. Approved signals include flares, orange smoke, an orange distress flag, or an electric distress light.

LIGHTING

For nighttime and any low visibility condition, your boat must be operated with USCG approved navigation and anchor lights that comply with applicable law.

Additional Recommended Equipment

In addition to the required safety equipment, there are additional items that will provide an extra margin of safety and convenience for you and your passengers while boating, such as:

- Anchor with at least 100' of rode
- Mooring lines and fenders
- Combination oar/boat hook
- Mooring lines and fenders
- Lubricant
- Tool kit
- Spare engine fuses (see engine operator's manual)
- Local charts and compass
- Waterproof flashlight
- Portable AM/FM radio with weather band
- VHF radio
- EPIRB
- Radar
- Satellite Navigation
- Night Vision Cameras
- Life Raft
- Spare flashlight and radio batteries
- Sunglasses and sun block

Keep tools and spare parts in good condition. Replace parts removed from spare parts kit. Most importantly use U.S. Coast Guard approved or marine certified parts where applicable. Any condition found requiring corrective action should be serviced by a qualified repairman.

EMERGENCIES

While boating, unpleasant situations may develop. Before emergency situations materialize you should prepare yourself to cope with them, whether they happen aboard your vessel or someone else's. Prepare a game plan for specific situations that may occur such as inclement weather, collision, fire, man overboard or collision, to give you the confidence and ability necessary for an emergency.



Storms

Getting caught in severe weather is hazardous. The best advice for boaters in bad weather is to **STAY HOME**. Check with local weather stations, the U.S. Coast Guard, or National Weather Service broadcasts for the latest conditions. (162.4-162.55 MHz) We recommend you check the weather not only before but periodically while you are boating, as weather conditions can change rapidly. If a

storm approaches a) return to port or seek safe harbor immediately; b) make sure all persons aboard are wearing a PFD; and c) reduce your speed and head into the wind. When a lightning storm advances certain safety precautions should be taken. Dock the boat and seek shelter on land. If this is not possible seek refuge inside the boat until the storm has passed. Stay out of the water! Lightning will seek a ground when it strikes and may pass through metal components if it hits your boat. Avoid contact with metal parts of the boat under these conditions.



Fog

If you encounter fog, set a course using your compass and navigational chart. Reduce your speed. Have everyone aboard act as lookouts to prevent collisions. Sound your horn intermittently to warn others of your presence. You must also listen for signals from other boaters in the area.



Fires

A fire aboard your boat is very serious. In case of fire, you should immediately stop your boat and shut off the engine. Have everyone aboard put on their personal flotation device. If the fire is accessible, use the fire extinguisher at the base of the flames using a sweeping motion.

If the fire cannot be extinguished within a few minutes, use a distress signal and call for help on the radio. All persons should jump overboard and swim clear of the burning boat.



Swamping and Capsizing

Any boat can capsize or swamp if not operated properly. That bears repeating. ANY BOAT CAN CAPSIZE OR SWAMP. This is especially true of boats equipped with t-tops and/or towers. It usually happens when least expected. To reduce the risk of capsizing or swamping: a) avoid operating your boat in adverse weather conditions (i.e., never operate any boat when there is small craft advisory, and never operate a boat



that is less than 22' in length in greater than 10kt winds or 2' seas); b) ensure that your boat is loaded as level as possible (both front to back as well as side to side); c) do not allow items to shift in the boat during navigation; d) never install towers, t-tops or other similar accessories not manufactured by us or endorsed for purchase by us; d) reduce power and speed in turns. If you're operating a boat with a tower, avoid seas greater than 2'. In the event your boat swamps, floods or capsizes, you should:

- Stay calm
- Try to turn the engine OFF to prevent damage.
- If not already wearing them, have everyone aboard put on their personal flotation device.
- Locate all passengers and guide them to (and into if possible) the boat.
- Stay with the boat as long as it is afloat.
- Climb up on the hull and signal for assistance if the boat lists or turns over.
- Do not attempt to swim to shore. It's farther than it looks.



Note: This guy should be wearing a life preserver.

Boats under 20' are built using flotation foam and stay relatively level when swamped. The crew may be able to bail the cockpit out and restart the engine.



Collisions

If you are involved in a collision first check everyone aboard for injuries and then inspect the boat for damage.

- Attempt to plug any holes you find.
- Use a manual bilge pump to remove water if possible.
- If the boat is in danger, have everyone put on PFDs.
- Signal for help.



Rendering Assistance

The owner or operator of a vessel is required by law to render all practical or necessary assistance to any person or vessel affected by collision, accident or casualty. However, you should not endanger your vessel or passengers to render assistance.



Towing or Being Towed

In the event of a mishap or power loss you may need to tow a boat or have yours towed. Remember you should not tow a boat larger than your own. Never tow a boat if you are not equipped with the proper lines. Nylon ropes are recommended. They have the strength and elasticity needed to absorb the shock of towing and sudden jerks. Individuals should never hold a towline; always secure it to the boat. Before towing a boat, make a bridle and tie it securely to the stern eyes on the transom with enough slack to clear the engines. Pad the line wherever it comes into contact with the boat to prevent chafing. Attach a tow line to the bridle so that it can slide from side to side to prevent too much pressure on a single pad eye. The tow line should then be attached to the bow eye or to a bridle on the towed boat. The tow line should be a minimum of twice the length of the towing boat, the longer the better. When passing the tow line to the other boat do not try to run in too close. Send either a light line or attach the towline to a life preserver to be pulled in. Beware of the other boat's propeller. The towed boat should always have someone at the wheel since the boat may swing off course. Start the tow off slowly. A steady pull at a moderate speed should be used. It is important to keep the slack out of the propeller area. Watch the action of the towing boat. If excessive slack develops in the towline and contact is obvious turn in either direction to avoid hitting the stern. As a precaution passengers on both boats should stay clear of the tow line. Lines under stress could snap and fly in either direction causing injury.



Accident Reporting

Report all boating accidents to your local authorities. Federal regulations require boat operators that are involved in an accident to submit a written report within 48 hours. In the event of death or disappearance notification is required immediately by phone or radio in addition to the written report. These reports can be submitted to the State Boating Law Administrator. Forms can be obtained through the USCG, local harbor patrol offices, sheriff and police stations.

BOATING CLASSES AND LITERATURE

Although we include some basic boating tips in this manual, a thorough review of the safety rules and regulations for boating is beyond the scope of this text. You must complete one of the safety courses approved by the U.S. Coast Guard or the Florida Fish and Wildlife Commission (e.g., <http://www.myfwc.com/boating/safety-education/courses/>) prior to operating your boat. In addition, we recommend that consult with the following agencies for further recommendations on safe boating:

- United States Coast Guard
- United States Coast Guard Auxiliary
- United States Power Squadrons

Additional boating knowledge can be obtained from some of the following periodicals:

PILOTING, SEAMANSHIP AND SMALL BOAT HANDLING

(Chapman) Motor Boating and Sailing
Post Office Box 2319 —F.D.R. Station
New York, New York 10022
Available on CD ROM or as a book.

PLEASURE BOATING AND SEAMANSHIP (US Coast Guard Auxiliary)

306 Wilson Road
Oaklands Newark, Delaware 19711

BOATMAN'S HANDBOOK by Tom Bottomly

Post Office Box 2319 —F.D.R. Station
New York, New York 10022

For more information on boat operation courses in your area, call BOATING EDUCATION HOTLINE 1-800-336-BOAT (2628), US COAST GUARD BOATING HOTLINE 1-800-368-5647 or contact your local coast guard office.

PRODUCT CHANGES

We are committed to the continuous improvement of our boats. As a result, some of the equipment described in this manual or pictured in our marketing material may change or no longer be available. All information, illustrations and specifications contained in this manual are based on the latest product information available at the time of publication. We reserve the right to make changes at any time and without notice to colors, materials, equipment, specifications and models.

MAINTAINING YOUR BOAT

The amount of maintenance required to keep your boat operating properly and to maintain the appearance is dependent on how the boat is used, the amount of usage, the type of water it is operated in (saltwater is exceptionally corrosive), climate, any a myriad of other factors. The bilge area of your boat should be kept clean and dry. Leaks found early and corrected are less likely to cause damage. Do not allow grease and dirt to build up. Proper maintenance of your boat is not only a source of pride; it is the key to maintaining your boat's value. A few simple steps will keep your boat looking great for years.

Fiberglass Finish

The exterior finish of your boat has a thin layer of resin with a finished color pigment called gelcoat. The purpose of gelcoat is to protect the inner laminate from moisture and chemicals, as well as provide the colored finish that is customary for fiberglass boats. Although gelcoat looks like a hard, smooth surface it actually moves and flexes with the composite substrate. However, gelcoat is not as flexible as the fiberglass composite structures beneath it. Gelcoat also contains microscopic pores that trap dirt, grime, pollutants and other things that create surface discoloration. While UV light inhibitors are added to gelcoat, they reduce the speed of damage, but do not prevent damage, caused by exposure to the sun. Like asphalt on a road, upholstery on seating and paint on a car, gelcoat does not last forever. It steadily degrades over time. It is going to wear, crack, craze, oxidize, fade, become more brittle and discolor over time. Once this happens, you must either professionally repair the area. To slow this process down, keep your boat fully covered and, if you have the means, in covered storage whenever it is not in use.

Cleaning

Normal exterior finish maintenance of your boat is similar to the care you would give your automobile. Do not use caustic, highly alkaline cleaners or those containing ammonia. These cleaning agents will discolor the gelcoat. The best way to slow the degradation of your gelcoat is to clean the boat after each outing and regularly with a mild household detergent and plenty of fresh water. Use a sponge on smooth surfaces including the deck and a brush on the non-skid areas. Rinse away all grime and residue. Even with regular cleaning, invisible impurities caused by environmental pollutants will accumulate and negatively impact the finish and flexibility of your gelcoat.

Waxing

Gelcoat will stain, yellow, discolor, become brittle and lose its gloss due to exposure to uv-light, the environment and pollutants. It requires special attention to maintain its gloss and color. In general, we recommend a coat of quality carnauba wax on all smooth surfaces immediately upon taking possession of your boat, followed by a coat of Woody's Wax (or similar) on all non-skid areas. You can consult a professional for advice on a wax schedule appropriate for your region, but a full coat of wax should be applied no less than once each six months to stave off stains, yellowing, cracking, crazing and surface discoloration. In general, wax seals the pores and enhances the look of your boat. Do **not** use traditional wax on non-skid surfaces or they will become slippery. Whenever waxing your boat be sure to inspect the surface for any damage. Have the damage corrected as soon as possible. Gelcoat ages, dulls, yellows, cracks, crazes and discolors naturally over time. Factors that affect the rate of degradation include the sun, pollution, wax, sunscreen, cleaners, and the salt content of the water in which the boat is operated. Polishing compound (fine abrasive) or rubbing compound (coarse abrasive) can sometimes be used to remove some of the degradation. These products can be applied by hand or by mechanical means. To help restore fiberglass finishes, clean the affected area with a good detergent and remove stubborn stains or discoloration by gently wet sanding the affected areas with 600 grit "wet or dry" sandpaper. Use plenty of water and sand curves in the same direction. Dry the area to make sure all the discoloration has been removed. Repeat this process if necessary. Buff using a polishing compound suitable for fiberglass, an electric buffer (1750-1800 RPM) and an 8-inch lamb's wool pad. Follow with a coat of wax immediately.

Gelcoat Repair

We do not manufacture gelcoat. While it is a relatively durable material, it is not perfect nor is it particularly long-lasting. Gelcoat is susceptible to stains, yellowing, scratches, blistering, crazing and cracks over time. Gelcoat is generally elastic enough to withstand the boat's movement, but sometimes and in some places it is not. Corners are notorious for gelcoat cracks because of the

amount of movement concentrated at them. Gelcoat cracks are cosmetic not structural. They do not affect the structural integrity of your boat and are not covered under your warranty.

Bottom Paint

If your boat is left in the water for more than a few days at a time, the hull bottom (below the waterline) should be painted with antifouling paint to protect it from marine growth and blistering. All boats will blister if not painted with anti-fouling paint. Since anti-fouling paint slowly dissolves to prevent marine growth, it is advisable to inspect and clean the boat bottom at least once per season. Re-paint when necessary. To help prevent blistering use an epoxy barrier coat applied in conjunction with the antifouling paint.

Canvas

Although your boat's canvas is made using high quality fabric and sewing techniques, your boat's canvas will not be completely leak proof. The seam holes in your canvas will no doubt stretch and leak. We do not warrant canvas to be watertight. To maintain your boat's canvas the fabric should be cleaned regularly to prevent soil build-up that will become embedded in the fabric. Simply brush off any debris, hose down canvas and clean with a mild solution and warm water. Do not use petroleum or ammonia based cleaners on canvas or clear vinyl, they will cause the canvas to turn yellow. For heavily soiled fabric remove top from frame. Water repellent was applied to your canvas during manufacturing. After various cleanings some of the repellent may have been released and retreatment of the fabric is recommended. Do not use wax-based products. Use a water-based repellent such as Apseal® or Uniseal™. Scotchguard® is effective for short-term use only. When cleaning Sunbrella fabrics, it is important to always use a mild soap (i.e. Ivory Snow, Dreft or Woolite). Never detergent. Water should be cold to lukewarm. Never more than 100 degrees and air dry only. Never apply heat to Sunbrella fabrics. If you are cleaning Sunbrella while still on an awning frame or a boat, follow these simple steps:

- Brush off loose dirt.
- Hose down.
- Prepare a cleaning mixture of water and mild soap (no detergents).
- Use a soft bristle brush to clean
- Allow soap to soak in
- Rinse thoroughly.
- Air dry.

If stubborn stains persist, you can use a diluted chlorine bleach/soap mixture for spot cleaning of mildew, roof run-off or other similar stains. Prepare a special cleaning mixture:

- Eight ounces (one cup) of chlorine bleach.
- Two ounces (one-fourth cup) of mild soap.
- One gallon of water.
- Clean with soft bristle brush.
- Allow mixture to soak for up to 20 minutes
- Rinse thoroughly.
- Air dry.
- Repeat if necessary

Remember to protect the area around your Sunbrella if using a bleach solution. Carpet or other fabrics that are not Sunbrella may have an adverse reaction to the bleach. If an awning or boat cover is suitable in size for a washing machine, these steps should be followed:

- Use only mild soaps. No detergent.
- Wash and rinse in cold water.
- Air dry. Never put Sunbrella fabrics in your dryer.
- Re-treating the Fabric

As part of the finishing process, Sunbrella fabrics are treated with a fluorocarbon finish, which enhances water repellency. This finish is designed to last for several years, but must be replenished after a thorough cleaning. We recommend 303 High Tech Fabric Guard™ as the preferred retreatment product for Sunbrella fabrics. Fabrics should be retreated after thorough cleaning or after five years of use. 303 should be applied to Sunbrella fabrics after each thorough cleaning, which typically removes the original fluorocarbon finish and reduces the fabric's water repellency. After cleaning the fabric, allow it to air dry completely and then apply 303 in a thin, even coat. After allowing the first coat of 303 to air dry, apply a second thin, even coating of 303. Two light coatings are more effective in restoring fabric water resistance than a single heavy coating. A 15-ounce bottle provides coverage of up to 50 square feet of lightweight fabric. Always apply 303 to clean fabric.

Zippers and Snaps

Zippers and snaps will loosen with use. Use care when starting the zipper to prevent damage. Lubricate the snap buttons and zippers with petroleum jelly or paraffin. Fasteners should be unsnapped as close to the button as possible. We recommend using "Snap-Stick" on all snaps to prevent corrosion.

Vinyl Windows

Clean clear vinyl thoroughly with denatured alcohol and then apply a protective layer of clear wax. **DO NOT USE PASTE WAX – IT WILL TURN THE VINYL YELLOW.** This process should be repeated as necessary to maintain the protective wax coating. Remove vinyl panels and store indoors in a climate controlled environment. This will keep the vinyl from cracking. **NEVER FOLD THESE PIECES!**

Upholstery

Your exterior vinyl upholstery may be cleaned with a mild solution of household detergent and fresh water. Commercial cleaners for vinyl also work well. Since the seams of your exterior upholstery are not waterproof, your upholstery should be stored in a dry location or covered when not in use.

Hardware Mounting

When drilling holes for mounting hardware in boat surfaces make sure each hole is sealed properly. Sealing will reduce the risk of water leakage but may not prevent it. All holes can result in water intrusion and, depending upon placement, may not be evacuated from the boat.

Caulking/Gaskets

Deck fittings, bow rails, windows, hatches and similar items on your boat are caulked into place to create a water-resistant joint with the boat. However, the working action of normal use will flex the joint and eventually break down the seal. Periodically inspect the caulking for leaks and re-caulk as necessary.

Stainless Steel

When stainless steel items on your boat rust, that's your fault. It is caused by a lack of maintenance. Stainless steel needs regular cleaning to maintain its "less staining" properties. The key to maintaining stainless steel is to keep it clean with a mild solution of soap and fresh water. Remove salt or dirt from all metalwork after each use and on a regular basis. If corrosion begins, use a Scotch® bright pad and Woody's Wax® to remove it. Cleaning the stainless steel should be a part of your monthly maintenance routine.

Paint, Anodized, Powder Coat and Similar Coatings

Due to the harsh nature of a marine environment, it is vital to clean and maintain any surface that is painted, anodized, powder coated or sprayed with truck bedliner constantly. Failure to perform preventative maintenance will result in pitting, discoloration, peeling, flaking and corrosion of the coating and substrate. Parts that are painted, anodized powder coated or sprayed with truck bed liner must be washed after every use and every three weeks when not used with a mild soap (such as Ivory Liquid) and water solution. Strong cleaners and soaps must never be used nor should you use abrasive cleaners or products that contain chlorine bleach. These products can remove, discolor and/or corrode the coating. For maximum protection coat these parts with a non-abrasive coating (e.g., wax and metal protector). The best protectors will displace moisture, remove contaminants, and leave a waxy film/residue that protects the underlying coating and substrate. Follow the application guidelines for the product(s) you choose. Regardless of maintenance, don't expect these coatings to last forever. They don't. In a marine environment, well maintained paint, powdercoat, anodizing and bedliner can last five years or more. In some cases, environmental pollutants and the salinity of the surrounding air and water will decrease the life expectancy of these coatings regardless of how well you maintain them. If a part gets chipped or scratched, you should clean the area with soap and water and then sand the area followed by etching it with a chemical etching compound before applying a paint or similar coating over the affected area. This will prevent the start and spread of corrosion to the underlying substrate.

Scuppers and Drains

Drains and scuppers have flap assemblies and/or floating balls that restrict the flow of water. Inspect these areas periodically to make sure that they are free of debris. They must be periodically replaced immediately if they become damaged or no longer seal properly. Failure to do so could result in taking on water unnecessarily or sinking the boat.

Fuel System

You should be changing all fuel filters (including the fuel/water separator) annually. A good practice is to replace the primer ball at the same time. Primer balls are made of rubber and plastic and they become brittle and develop leaks over time. That process is accelerated in cold weather and exposure to saltwater. If you experience an issue that you suspect may be related to the fuel system you can test it by connecting a portable tank to the engine and operating it. If the problem persists the likely cause is with the engine itself. If the problem goes away, then the source must be in the boat's fuel system. One component that should be inspected if a restriction occurs is the anti-siphon valve. If fuel does not flow properly through this part it must be cleaned and/or replaced. This is not a permanent part. The rate of required replacement will vary depending upon environment, use and fuels, but you should plan to replace every two years at a minimum. Do not use fuels containing alcohol. Alcohol, particularly ethanol, absorbs water that makes fuel more corrosive to metals in tanks and carburetors. It also shortens the durability of elastomers such as hoses, primer balls and gaskets. After fueling, inspect the fuel hoses, connections, and tanks for tightness, signs of leaks, and deterioration. Annually conduct

a more detailed inspection of fuel system components, especially those hidden from routine inspection. Replace any fittings, deteriorated hoses, clamps or connections immediately.

Fuel Tank

If your boat has a fuel tank compartment it must be rinsed periodically, especially when used in a salt-water environment. Dirt accumulation attracts salt that creates salt crystals. Salt crystals can corrode metal surfaces if left untreated. To help protect your fuel tank from rust and/or corrosion rinse the compartment with FRESH water. Remove any access plates from over the fuel tank and inspect this area for leaks and loose lines. The access plates seal this area. Over time the opening and closing of these plates cause the associated O-rings to wear-out. Replace these o-rings as necessary to maintain the watertight integrity of the plates.

Batteries

The batteries in your boat has been selected to match the starting requirements of your engine. Batteries are secured in non-metallic trays to avoid electrolyte spills. If the battery is not sealed, fluid levels should be checked at least once a month. Fill the battery to the upper level with distilled water. Never overfill a battery. Keep terminals clean by scrubbing them with a stiff brush and a mixture of baking soda and water annually. Afterwards, apply a light coat of grease. The mixture should not enter the battery. When the batteries are not in use check them each month by using a battery hydrometer that measures the specific gravity. Batteries do not last forever and will need to be replaced periodically. Life span will vary depending upon use and operating locale, but two years is generally expected.

Electrical Connections

The wiring and electrical connections in a boat, especially those used in saltwater, are exposed to a more corrosive environment than wiring in your car/truck. As a result, extra care must be taken to promote long life of your electrical system. You should clean all connections thoroughly immediately following each use and coat all connections in di-electric grease every six months. Use of a salt inhibitor such as Salt-X or Salt Away is recommended as well. Finally, you must remember that a boat takes much more abuse and shock than an automobile, so you must constantly check and adjust the tightness of all electrical connections.

Fasteners

As just referenced above, a boat takes much more abuse and shock than an automobile. There is no shock absorbers or suspension. As a consequence, screws, bolts, nuts and all other forms of fasteners are subjected to significantly more stress. You **MUST** constantly check and adjust the tightness of all fasteners.

BOAT STORAGE

General Information

Boats stored during the winter or for an extended period require routine maintenance. Prior to and during the storage process the boat and its systems should be checked for maintenance and repairs. It is recommended that you arrange these repairs during the storage period. Avoid costly damage and delay when launching your boat by having it stored and winterized properly.

Lifting

To avoid personal injury and property damage it is advised to take extra precautions when lifting or moving the boat for storage. Our boats are typically equipped with stern eyes and bow eyes for trailering...not for lifting. For lifting, you must install lifting ring options that are suited for that

purpose. Rings and eyes should be inspected regularly to insure structural integrity. While transporting a boat by lift or tow motor the structure should remain as close to ground level as possible. If slings are necessary for lifting or transporting they should be in proper condition and tied together to prevent any movement (separating or slipping) which could cause damage to the boat. If tow motors are used to move the boat the forks should be padded and in a secure location under the hull near the chine. The forks should be long enough to prevent the boat from rocking forward and aft causing it to become unbalanced.

Winterization

Make sure the keel, chine and transom are fully supported. Indoor storage is beneficial particularly if your climate produces freezing weather. The storage unit should not be airtight but should be ventilated. Ventilation is extremely important both around and through the boat. For outdoor storage a canvas cover should be used to prevent "sweating". One method is to build a frame over the boat to support the canvas. It should be a few inches wider than the boat so the canvas will clear the rails and allow passage of air. The cover should be fastened securely so that winds cannot remove it or cause it to chafe the boat. A poor covering job will eventually cost more than the price of a well-made cover. **IF THE BOAT IS SHRINK WRAPPED WITH PLASTIC DURING STORAGE, THE FUEL FILL AND VENT FITTING MUST BE OUTSIDE OF THE ENCLOSURE TO PREVENT THE TRAPPING OF DANGEROUS FUMES OR SPILLAGE FROM THERMAL EXPANSION.** **CLEANING AND LUBRICATING THE BOAT.** Clean and wax the boat before storage. If your boat stays in the water there may be a layer of growth on the bottom. As it dries, this debris will harden. Clean, scrub, and scrape the bottom promptly when the boat is removed from the water. Thoroughly remove all marine growth and other foreign matter from the hull. Clean the inside of hull openings, thru hull fittings and scupper drains. Inspect the hull bottom for damage. Check cleats and rails for corrosion and tightness. Clean all stainless steel as directed under MAINTENANCE. Use a good quality metal preservative like T-9® on all metal surfaces to prevent salt water damage. Check all hinges for corrosion. Lubricate hinges as necessary. Check for loose silicone, hinges, and unseated gaskets. Replace or tighten where necessary. Heavy seas pounding and twisting the hull can cause leaks in your windows, doors and hatches.

Drainage and Water Systems

Remove the garboard drain plug and open all valves and seacocks to keep the bilge dry. Store your boat with the bow elevated for drainage. Drain all water tanks, lines and pumps to prevent freeze damage. The fresh water system may be drained by running any faucet until the tank is empty. When empty, turn the faucet off to prevent pump damage. Residual water will not damage the tank. If desired, the fresh water system may have a non-toxic antifreeze added. This antifreeze can be purchased at marine or camping dealerships. To drain other lines, close seacocks and run the pumps until the lines are dry. After lines are dry open the seacocks. In warmer climates draining will help prevent water stagnation. Many onboard drains have back flow balls that must be kept clean in order to consistently work as intended.

Batteries

Check the electrolyte level in your batteries and fully charge the batteries before storing. A weak battery loses its charge more rapidly than a strong battery. Ideally, you should disconnect the batteries and cover the terminals with grease to prevent corrosion. When replacing batteries in the boat remove excess grease from terminals and charge as necessary before reinstalling.

Engines

Check your engine owner's manual regarding the procedures for winterizing the engine(s). Follow these important instructions carefully, and your engines should survive most weather

conditions. Before putting the boat back in service, change all filters and check hoses and clamps. If you have any vibrations during the season look for loose engine bolts or damaged propellers.

Storage Checklist

In addition to the winterization guidelines, use the following checklist as a guide for storing your boat. Additional details should be added as needed for your personal application.

- Remove all loose items and personal effects.
- Remove any detachable and valuable equipment such as electronics.
- Store electronics inside in a dry and secure place.
- A built-in compass should be covered. Ultraviolet rays from the sun will “cloud” the compass and make it difficult to read.
- All equipment should be winterized as directed in the manufacturer’s manuals.
- Winterize engine
- Winterize fuel system
- Winterize Raw / Fresh water systems.
- Inspect & Lubricate trailer bearings and other recommended by the trailer manufacturer.
- Store cushions and canvas indoors in a dry place to prevent mildew.
- Clean the exterior and interior of the boat
- Remove all grease, oil, salt spray etc.
- Remove all garbage. Clean the cabinets, lockers / storage, and fish boxes and live wells.
- The lids and doors should be propped open for ventilation
- Empty toilet / head and flush with fresh water
- Lubricate all hinges, valves, the backs of electrical panels and other items that may rust.
- Check underwater items. Hardware should be in good condition and tight. Inspect electrical systems and have any necessary repairs performed